



mySewnet™ Thread Cache

Reference Guide

Mac®

The software to which this Reference Guide relates is subject to change without notice. All efforts have been made to ensure the accuracy of the contents of this Reference Guide.

The software described in this book is furnished under a license agreement and may be used only in accordance with the terms of the agreement.

Permission is hereby granted to the licensee of the software to which this guide is related to reproduce and distribute copies of this guide for nonprofit educational purposes. The copyright statement on this page must be included on any copy of this work.

Acrobat®, the Adobe PDF logo and Reader are either registered trademarks or trademarks of Adobe Systems Incorporated in the United States and/or other countries. Other product names mentioned in this guide may be trademarks or registered trademarks of their respective companies and are hereby acknowledged.

mySewnet, VIKING, PFAFF, PREMIER+ and 6D are trademarks of Singer Sourcing Limited LLC

HUSQVARNA is the trademark of Husqvarna AB.

**© 2021 Singer Sourcing Limited LLC
All rights reserved. (Version A)**

Contents

- 1 Chapter 1: Welcome to mySewnet™ Thread Cache
- 3 Chapter 2: Using mySewnet™ Thread Cache
 - 4 My Thread Ranges
 - 5 My Thread Databases
 - 6 My Thread Stock
 - 9 Backup and Restore
- 10 Chapter 3: My Thread Ranges
 - 11 Organize My Thread Ranges
- 13 Chapter 4: My Thread Databases
 - 14 Find Threads
 - 15 Add Standard Threads to a My Thread Database
 - 16 Add a New Thread to a My Thread Database
 - 20 Colors Window
 - 20 Copy Thread
 - 21 Organize a My Thread Database
 - 22 Add a New My Thread Database
- 26 Chapter 5: My Thread Stock
 - 26 My Thread Stock
 - 29 Edit Selected
 - 31 Print
 - 33 Upload
- 34 Chapter 6: The Thread Cache Website
 - 35 View Your Threads on Your Mobile Device
 - 35 Using the Thread Cache website on your mobile
- 40 Chapter 7: Preferences
- 41 Chapter 8: Troubleshooting
 - 41 Error Messages
 - 41 Other Topics
- 44 Chapter 9: Index

Welcome to mySewnet™ Thread Cache

Use mySewnet™ Thread Cache to list your personal thread collection, to create a list of favorite thread ranges, and to view your threads on your phone or tablet.

Use mySewnet™ Thread Cache  to list your personal thread collection in one or more My Threads palettes and print a My Threads shade card. Create your own list of favorite thread ranges, too. Use My Threads palettes and My Thread Ranges to choose from only the threads you own when changing or adding colors in the mySewnet™ Embroidery Software.

Finding Information

Reference Guide

The Reference Guide shows how to start the app and provides a quick tour of the main screen. It also contains full reference information. The Reference Guide is supplied in PDF format .

Help

The integrated help contains full reference information. Click the Help button . Where available, a help topic appears that is relevant to the selected item. Alternatively, use the Help menu.

Viewing and Printing PDF Guides

To find all the Reference Guides for your mySewnet™ Embroidery Software, go to the mySewnet™ Guides page, linked to from download.mysewnet.com. Select the desired PDF guide.

Note; To view and print the PDF Guides, you may use Preview which is included in your Mac OS® .

Readme

The most up-to-date details about the mySewnet™ Embroidery Software are in the Readme.rtf file available when you install your mySewnet™ Embroidery Software.

Sample Files

Samples are provided for your use. Download the sample files from the Downloads page: download.mysewnet.com. Copy the samples folder to the folder of your choice.

Note: For the exercises in these manuals, the mySewnet folder is used.



About mySewnet™ Thread Cache

Access via the mySewnet™ Thread Cache menu. The version number of mySewnet™ Thread Cache is given here. You will need this if you contact technical support at any time.

Starting mySewnet™ Thread Cache

- Click the mySewnet™ Thread Cache icon  in the Launchpad.
- Double-click the mySewnet™ Thread Cache icon  in the Finder.

Minimize and Maximize

- Use the yellow minimize button  at the top left to minimize the current window.
- Use the green zoom button  at the top left to switch between a larger and smaller window size.

Quit mySewnet™ Thread Cache

- Choose mySewnet™ Thread Cache > Quit mySewnet™ Thread Cache.
- Use the red close button  at the top left.
- Press **⌘Q**

Using mySewnet™ Thread Cache 2

Use mySewnet™ Thread Cache to organize your thread ranges as My Thread Ranges and create personal My Thread databases. Print or upload a thread list for use on the move.

Use mySewnet™ Thread Cache to organize your preferred thread ranges in a list called My Thread Ranges and your personal thread collection in one or more My Thread palettes. Use the buttons (tabs) at the top of the mySewnet™ Thread Cache screen to change the view between My Thread Ranges, My Thread Databases and My Thread Stock.

Print a list from your My Thread databases, or upload your My Thread databases to the Thread Cache website. Note your thread purchases as you visit different stores.

To learn how to	Go to
Create and modify a list of favorite thread ranges.	See “My Thread Ranges” on page 10.
Choose the threads from many different manufacturers and list them together in a My Thread database.	See “My Thread Databases” on page 13.
Note the quantity of each thread in the selected thread database, and print a list or upload to the Thread Cache website to view on your mobile device.	See “My Thread Stock” on page 26.
Use Thread Cache on your mobile device to review your threads when on the move, and to note your thread purchases.	See “The Thread Cache Website” on page 34.
Create a thread database in mySewnet™ Thread Cache and upload it to the Thread Cache website for use on your mobile device.	See “Create a My Thread Database and Upload it for your iOS Device” on page 6.

Overview

- Use My Thread Ranges to create a group of favorite personal and manufacturer thread ranges for use when selecting thread colors.
- Use My Thread Databases to create a My Thread database of the manufacturer and personally created threads that you own. Select threads from this range when designing embroideries.
- Use My Thread Stock to record how many spools you have for each thread in the selected My Thread database, and to highlight and annotate threads for which you need extra spools. Print a list, or upload the database to the Thread Cache website to view on your mobile device.

- Use Thread Cache on your mobile device to view your threads, and note the threads as you purchase them.

My Thread Ranges

Use the My Thread Ranges window of mySewnet™ Thread Cache to create and modify your list of favorite thread ranges. My Thread Ranges is used in the Color Selection dialog to make it easier to select your favorite thread ranges.

The standard thread ranges are grouped by manufacturer.

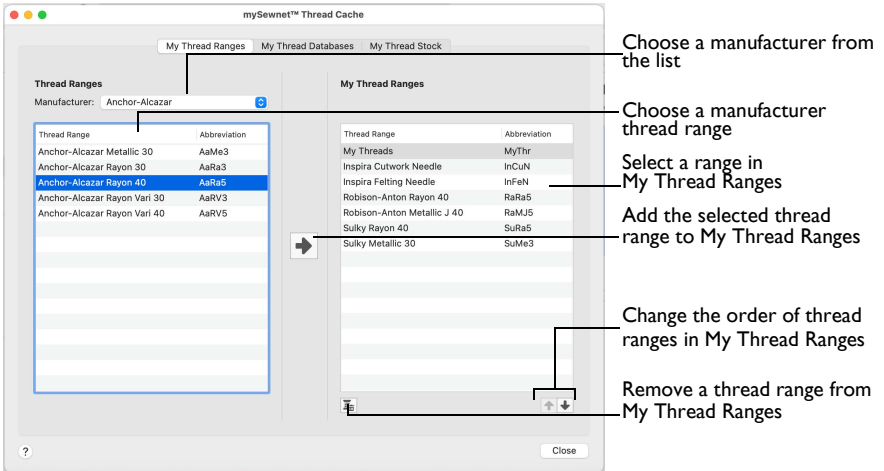



Move thread ranges up and down your list of My Thread Ranges, and Delete unwanted thread ranges.

My Thread Databases

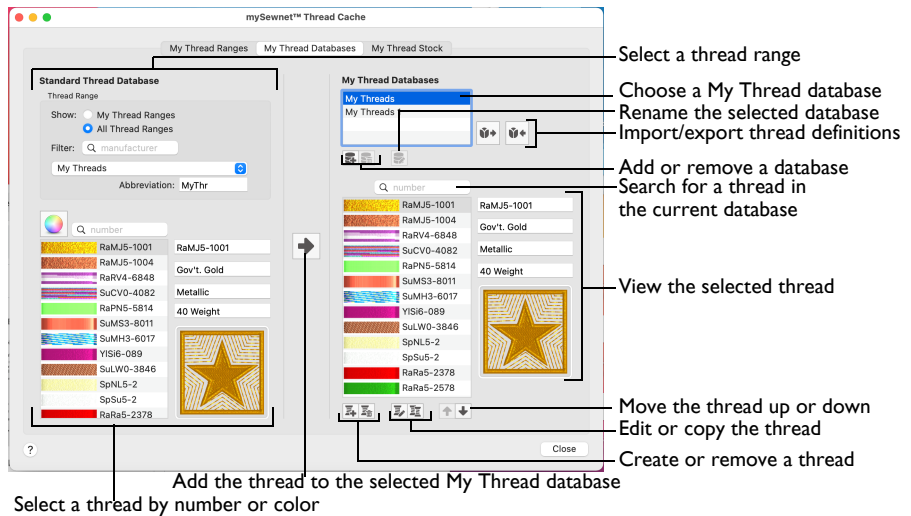
Choose the threads you own from many different manufacturers and list them together in a My Thread database.



Note: The abbreviation for the Thread Range is automatically added before the number in a My Thread database; for example SuMS3 for Sulky Metallic Sliver 30 weight. If the whole of a My Thread database that you create is from one new manufacturer, create an appropriate database name and the abbreviation will be added automatically.

You may create new custom threads, or copy and modify existing threads. Select threads in the standard thread ranges by color using the Colors window. Alternatively, use Import Threads from Embroidery  to add custom colors and databases from a friend, or Export Threads to Embroidery  to give thread definitions to a friend, or backup your My Thread database.

Note: When threads are added to a My Thread database, they are shown in the Color Selection dialog the next time it is used in any mySewnet™ Embroidery Software app. You cannot add Color Effects to threads in mySewnet™ Thread Cache, use the Color Selection dialog in other mySewnet™ Embroidery Software modules.

Updating the Standard Thread Database

If your friends give you .vp4 format embroideries they have created, the embroideries may contain thread definitions from a later version of the standard thread database. In order to have these colors available, the updated Standard Thread Database must be downloaded and installed.



See Check for Updates in the mySewnet™ Configure Reference Guide.

My Thread Stock





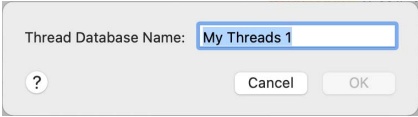





Use the My Thread Stock window of mySewnet™ Thread Cache to note the quantity that you have of each thread in the selected My Thread Database, and to print the list or upload it to the cloud, ready to view on the Thread Cache website on your mobile device.

Color	Number	Name	Type	Weight	Spools	Size	Notes
Yellow	RaMJ5-1001	Gov't. Gold	Metallic	40	0	1,000 m	
Copper	RaMJ5-1004	Copper	Metallic	40	1	1,000 m	
3CC Purple	RaRV4-6848	3CC Purple	Rayon	35	1	1,000 m	
Wild Rose	SuCV0-4082	Wild Rose	Cotton	12	1	1,000 m	
Neon Green	RaPNS-5814	Neon Green	Fluorescent	40	1	1,000 m	
Lt. Copper	SuM3S-8011	Lt. Copper	Metallic Silver	30	1	1,000 m	
Peacock Blue	SuMH3-6017	Peacock Blue	Metallic Holographic	30	0	1,000 m	
Dark Rose	YIS6-089	Dark Rose	Silk	50	1	1,000 m	
Bracken	SuLW0-3846	Bracken	Wool	12	1	1,000 m	
Yellow ExtraGlow	SpNL5-2	Yellow ExtraGlow	Cotton	40	0	1,000 m	
White / Green	SpSu5-2	White / Green	Cotton	40	1	1,000 m	
Red	RaRa5-2378	Red	Rayon	40	2	1,000 m	
Harvest Green	RaRa5-2578	Harvest Green	Rayon	40	0	1,000 m	
Soldier Blue	RaRa5-2527	Soldier Blue	Rayon	40	2	1,000 m	
Daffodil	RaRa5-2326	Daffodil	Rayon	40	2	1,000 m	
Yellow	RaRa5-2213	Yellow	Rayon	40	2	1,000 m	
Periwinkle	RaRa5-2306	Periwinkle	Rayon	40	0	1,000 m	
Passion	RaRa5-2291	Passion	Rayon	40	2	1,000 m	
Iris	RaRa5-2288	Iris	Rayon	40	2	1,000 m	

Create a My Thread Database and Upload it for your iOS Device

- 1 In mySewnet™ Thread Cache, click the My Thread Databases button.
- 2 In the My Thread Databases section, click Add New Database .
- 3 In the Thread Database Name dialog, enter a name for the new thread database. A name is suggested (such as "My Threads 1") but you can enter any name you choose.
- 4 Click OK to create the new database.
- 5 Click the My Thread Ranges button.
- 6 Click your new My Thread database to highlight it.
- 7 Click the Add To My Thread Ranges arrow  button. My Threads 1 is added to the end of the My Thread Ranges list.

Note: Your new thread database will now be listed when you select My Thread Ranges in the Color Selection dialog.
- 8 Click the My Thread Databases button.
- 9 In Thread Range, select My Thread Ranges.
- 10 In the pop-up menu, choose a manufacturer's thread range, for example Sulky Rayon 40, from the list. The list of threads changes according to the chosen range.
- 11 Click in the Number box and enter 1023. As the number is entered, the thread appears.
- 12 Click the color block to select it, and its details are shown, 1023 (Yellow).

- 13 Then click the Add To My Threads arrow  button. The thread SuRa5-1023 is added to the My Threads I database in the pane on the right.
- 14 Delete all text in the Numbers box, and the full list of colors reappears.
- 15 Click Select by Color .
- 16 Click Colored Pencils  to select the Colored Pencils color model.
- 17 Click the green, number 5 in the second row. Thread 1277 (Ivy Green) is selected.
- 18 Click Add To My Threads  to add it to your list of colors. Use the Colors window to select the nearest shade to the color you choose that is available from the current thread range.
- 19 Use the Colored Pencils to add a blue and a red to your list of threads, then close the Colors window.
- 20 Below your new list of threads, click the Add New Thread  button. The Thread dialog appears. For more information, see “Add a New Thread to a My Thread Database” on page 16.
- 21 Enter a Thread Number, for example 4000.
- 22 Enter a Thread Name, for example MyBlueThread.
Note: The Thread Number can be up to 13 characters, including letters. The name can be up to 29 characters.
- 23 Choose the Thread Type from the pop-up menu.
- 24 Choose the Thread Weight from the pop-up menu.
- 25 Click the color block in Single Color, and use the Colors window to select a blue color for the thread.
- 26 Click OK to create the thread.
- 27 Click Move Up . The blue that you just created moves one place up the thread list.
Note: Use Move Down  to move a color down the list, and Delete  to remove a color from the list. Use Edit  to change a thread, and Copy Thread  to copy an existing thread to use as the basis for a new thread.
- 28 Click the My Thread Stock button.
- 29 In the My Thread Database pop-up menu, ensure that My Threads I is selected.
- 30 Click the Name column heading. The database is sorted by name.
Note: You can sort by any of the headings.
- 31 Click the Reset Sort Order button. The list returns to its original order.
- 32 Highlight the blue thread that you created, and then click the Notes field for that thread to open it for editing.
- 33 Enter the text "3 spools needed" and press Return. The note is added to the blue thread.
- 34 Highlight the yellow thread and click the Quick Spool Count +1  button. There is now one spool of the yellow thread.
- 35 Command-click to select the green and red threads. Both are highlighted.

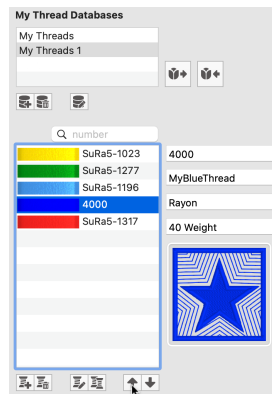

- 36 With the threads still selected, click the Edit Selected button. The Edit Selected dialog opens.
- 37 Select (check) the "Set number of spools to all selected" checkbox.
- 38 Set the number of spools to 3.
- 39 Select (check) the "Set notes to all selected" checkbox.
- 40 Enter the text "I spool needed" in the Notes text box.
- 41 Click OK. Both threads are now listed as having 3 spools, and needing an extra spool.

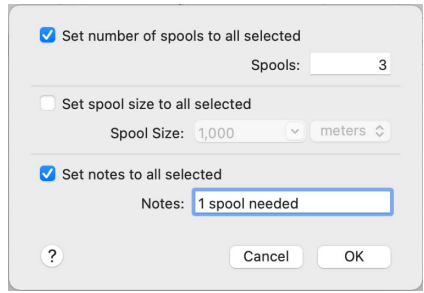

Note: Use the Edit Selected dialog to change the spool number, size, and the notes for several threads at the same time.

- 42 Click in the Star column for the first of your selected threads. The thread is highlighted with a star.
- 43 Add a star to the other two threads with notes.
- 44 Click the column header star to sort by this column. All of the highlighted threads are now listed together. This is a good way to review your highlighted threads. For more information, see "Viewing and Sorting Threads in a My Thread Database" on page 27.

* Color	Number	Name	Type	Weig...	Spools	Size	Notes
	SuRa5-10...	Yellow	Ray...	40	1	1,000...	
	SuRa5-572	Blue Ribbon	Ray...	40	0	1,000...	
	SuRa5-1277	Ivy Green	Ray...	40	3	1,000...	1 spool needed
	4000	MyBlueThread	Ray...	40	0	1,000...	3 spools needed
	SuRa5-1184	Orange Red	Ray...	40	3	1,000...	1 spool needed

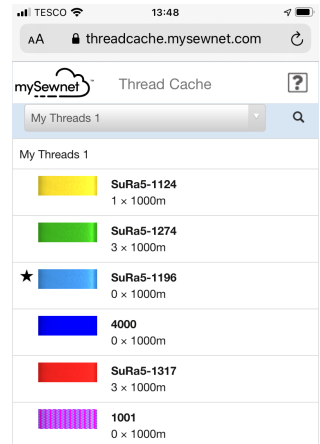

- 45 Click the Upload button . Your threads are uploaded to the mySewnet™ Thread Cache website.
- 46 Open the mySewnet™ Thread Cache website on your mobile device: threadcache.mysewnet.com
Note: You may be asked to log in to your mySewnet™ account.
- 47 Your thread databases are shown.



- 48 In the main window, select your personal thread database (here My Threads 1) from the My Threads pop-up menu.
- 49 Tap one of the threads to see its details.
- 50 In the Thread pane, tap Purchased to set the thread to Purchased.
- 51 Tap Back to go back to the My Threads window. The thread is now marked with a P.
- 52 In the My Threads pop-up menu, select Star Threads. Only your star threads are displayed. See "The Thread Cache Website" on page 34..
- 53 When you are back at your computer, update the thread spool information in your My Thread databases in mySewnet™ Thread Cache.



Backup and Restore

Use Backup My Settings  and Restore My Settings  to backup and restore your My Thread databases and your My Thread Ranges. Backup My Settings and Restore My Settings are on the Utilities window of mySewnet™ Configure.

It is recommended to use Backup My Settings  after making significant changes to your My Thread databases and your My Thread Ranges.

Use the My Thread Ranges window of mySewnet™ Thread Cache to create and modify a list of favorite thread ranges.

Use the My Thread Ranges window of mySewnet™ Thread Cache to create and modify your list of favorite thread ranges. My Thread Ranges is used in the Color Selection dialog to make it easier to select your favorite thread ranges.

The standard thread ranges are grouped by manufacturer.

To open the My Thread Ranges window

- In mySewnet™ Thread Cache, click the My Thread Ranges button.
- Choose View > My Thread Ranges
- Press ⌘1

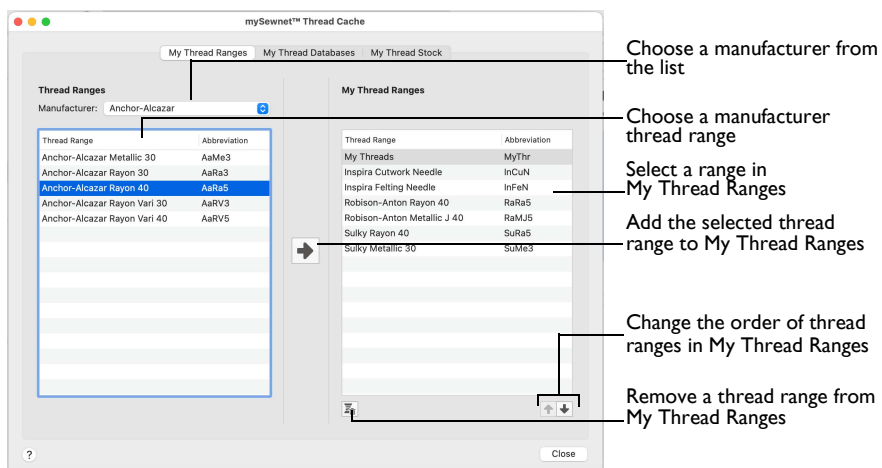

Move thread ranges up and down your list of My Thread Ranges, and Delete unwanted thread ranges.

To learn how to	Go to
Add Ranges to My Thread Ranges	See “Add a Thread Range to My Thread Ranges” on page 11.
Change the order of the thread ranges	See “Change the Order of My Thread Ranges” on page 11.
Remove a range from My Thread Ranges	See “Delete a Thread Range from My Thread Ranges” on page 12.

Select a Thread Range

- Choose a manufacturer or My Thread Databases from the Manufacturer pop-up menu, then click the desired thread range in the list.

Organize My Thread Ranges

Use the My Thread Ranges window of mySewnet™ Thread Cache to create and modify your list of favorite thread ranges. My Thread Ranges is used in the Color Selection dialog to make it easier to select your favorite thread ranges.

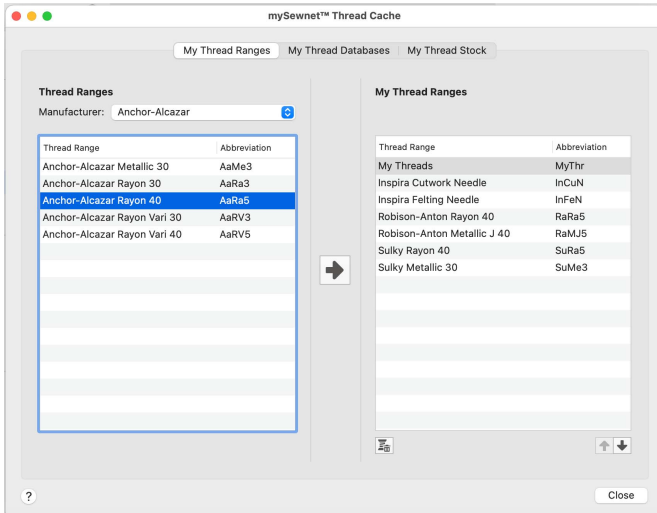

Add a Thread Range to My Thread Ranges

Add a Standard (Manufacturer) or My Threads (personal) thread range to My Thread Ranges.

Add a Thread Range

- 1 Choose the Manufacturer from the pop-up menu.
- 2 Click the desired thread range in the list to highlight it.
Note: To select multiple thread ranges, use Shift-click to select a consecutive sequence of thread ranges, or Command-click to select thread ranges individually.
- 3 Click the Add To My Thread Ranges arrow ➡ button. The selected thread range(s) are added to the end of the My Thread Ranges list.

Change the Order of My Thread Ranges

The thread ranges can be listed in My Thread Ranges in any order. Move the thread ranges within the list.

Moving a Thread Range in My Thread Ranges

- Click the desired thread range in the list, then click the Move Up ↑ or Move Down ↓ button below the list.

Delete a Thread Range from My Thread Ranges

Thread ranges can be deleted from My Thread Ranges. Only one thread range can be deleted at a time.

Note: It is possible to delete My Thread databases from My Thread Ranges. They will still be visible at the top of the All Thread Ranges list in the Color Selection dialog.

- Click the desired thread range in the My Thread Ranges list, then click the Delete  button below the list. The thread range is removed from the list.

Note: There is no confirmation message for deleting thread ranges from My Thread Ranges.

Choose the threads you own from many different manufacturers and list them together in a My Thread database. Create a new My Thread database.

Use the My Thread Databases window to choose the threads you own from many different manufacturers and list them together in a My Thread database. Create your own thread database, and add the threads you own to it.

Note: The abbreviation for the Thread Range is automatically added before the number in a My Thread database; for example SuMS3 for Sulky Metallic Sliver 30 weight.

To open the My Thread Databases window

- In mySewnet™ Thread Cache, click the My Thread Databases button.
- Choose View > My Thread Databases
- Press ⌘2

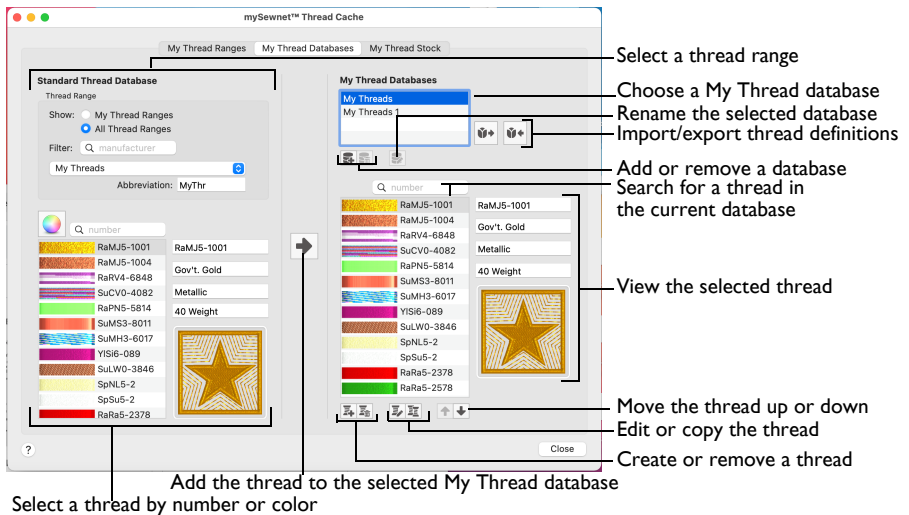

You may create new custom threads, copy and modify existing threads, or import threads from an embroidery. Select threads in the standard thread ranges by color in the Colors window.

If the whole My Thread database is from one new manufacturer, create an appropriate database name and the abbreviation will be added automatically.

Note: A sample thread database, My Threads, is available when mySewnet™ Thread Cache is installed.

Note: When threads are added to a My Thread database, they are shown in the Color Selection dialog the next time it is used in any mySewnet™ Embroidery Software app. Add Color Effects to selected threads within a design using the Color Selection dialog of mySewnet™ Embroidery Software apps.

To learn how to	Go to
Find a thread in a thread database	See “Find Threads” on page 14.
Add manufacturer threads to a My Thread database	See “Add Standard Threads to a My Thread Database” on page 15.
Create a new My Thread database	See “Add a New My Thread Database” on page 22.
Create a new thread for a My Thread database	See “Add a New Thread to a My Thread Database” on page 16.
Copy a thread to create a new thread	See “Copy an Existing Thread in a My Thread Database” on page 21.
Arrange the threads in a My Thread database	See “Organize a My Thread Database” on page 21.
Choose a thread color	See “Colors Window” on page 20.

Updating the Standard Thread Database

If your friends give you .vp3 or .vp4 format embroideries they have created, the embroideries may contain thread definitions from a later version of the standard thread database. In order to have these colors available, the updated Standard Thread Database must be downloaded and installed.

Use Check for Updates to ensure that the latest Standard Thread Database is present. See the mySewnet™ Configure Reference Guide.

Note: Alternatively, the embroideries may contain custom thread definitions from their My Threads databases. See “Import Threads From Embroidery” on page 23.

Note: A thread definition gives the name, number, thread type and weight, and the color for the thread (or colors for a variegated thread).

Find Threads

Find Threads in the Standard Thread Database Pane

- 1 Click the pop-up menu in the Thread Range section and choose the desired manufacturer’s thread range. The list of threads changes according to the selected range. Alternatively, enter the manufacturer name in the Filter box to reduce the list of thread ranges to those from the desired manufacturer, then select a thread range.
- 2 Click in the Number box.
- 3 Enter the desired thread number from the manufacturer’s range. As the number is typed, the first matching thread is highlighted and its details are shown. Alternatively, scroll down the list and select a thread.

Find Threads in the My Thread Databases Pane

- 1 Click in the Number box in the My Thread Databases pane.
- 2 Enter the desired thread number without the manufacturer's abbreviation. The first matching thread appears and its details are shown.

Alternatively, type the full thread number including the manufacturer's abbreviation. This is only necessary if you have threads with the same thread numbers from different manufacturers.

- 3 Click the color block to select it.

Add Standard Threads to a My Thread Database

Choose the threads you own from many different manufacturers and list them together in a My Thread database. The abbreviation for the Thread Range is automatically added before the number in the My Thread database; for example SuMS3 for Sulky Metallic Sliver 30 weight.

Note: It is not possible to add Inspira Cutwork or Felting Needles to a My Thread database.

Add Threads to a Database

- 1 In My Thread Databases, choose a personal thread database (for example, My Threads).
- 2 In Thread Range, select My Thread Ranges or All Thread Ranges.
- 3 In the pop-up menu, choose a manufacturer's thread range or a personal My Thread range from the list. The list of threads changes according to the chosen range.

Note: The thread range abbreviation is a short code for the manufacturer, the thread type and/or range name and then a number representing the thread weight (see "Thread Weight" on page 18).

- 4 To add a single color, either type in its number in the Find Thread box, or scroll through the list and click it to select it.

Alternatively, click Select by Color  and use the Colors window to select a color. The nearest shade that is available from the current thread range is selected. This is also a quick way to jump to threads of a color (for example, click light yellow in the Colored Pencils to jump to light yellow thread shades).

- 5 To add a consecutive sequence of colors, select the first color. Then hold Shift and click the last color. All the colors in the sequence are highlighted.
- 6 To add a selection of colors, select the first color. Then hold down Command and click other colors.
- 7 Click the Add To My Threads arrow  button and the chosen thread(s) are added to the end of the My Thread database list.

Note: If an identical thread already exists in the thread database, the thread will not be added. If a thread from another My Thread database is added, a code representing the name of the database is prefixed to the name.

Add a New Thread to a My Thread Database

You can add or customize your own thread information.

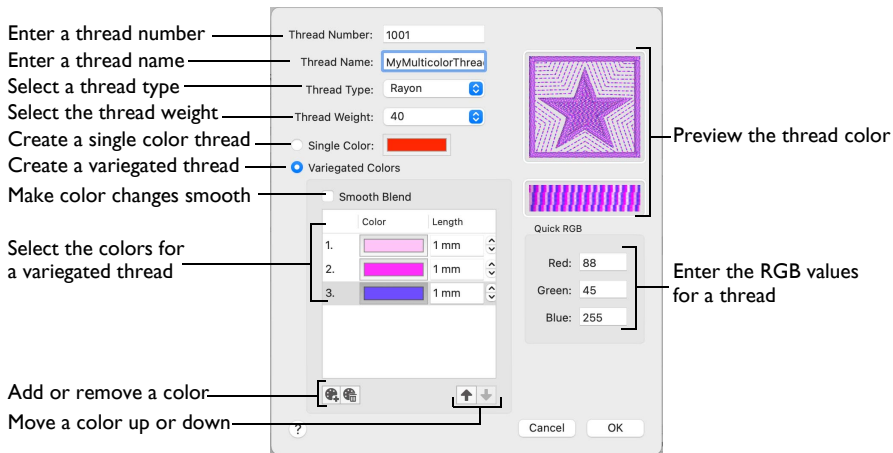



If you have threads that are not included in the Standard Thread Database, create a new My Thread Database with the name of the manufacturer, thread material and weight. When you add new thread to the My Thread Database, the abbreviation is added automatically.

Add a New Thread

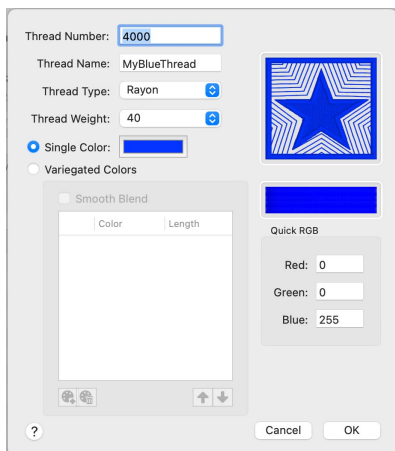
1 Click the Add New Thread button , and the Thread dialog appears.



Note: Use Copy Thread , then Edit , in a My Thread database to copy an existing thread to use as the basis for a new thread. See “Copy an Existing Thread in a My Thread Database” on page 21.





2 Enter the Thread Number. The number can be up to 13 characters long. It may include letters, for example to include an abbreviation for the name of the thread range.

Note: If the whole My Thread database is from one new manufacturer, create an appropriate database name and the abbreviation will be added automatically.

- 3 Enter the Thread Name, which is usually a description of the color.
The name can be up to 29 characters long.
- 4 Choose the Thread Type from the pop-up menu.
- 5 Choose the Thread Weight from the pop-up menu.
- 6 Click the color block in Single Color to use the Colors window to select a color for your new thread.
See “Add a Variegated Thread” on page 17 to create a multicolor thread.
- 7 Click OK to create the thread.

Add a Variegated Thread

Use the Variegated Thread options for multicolor threads.

- 1 Create a new thread, selecting Variegated Colors instead of Single Color. The default color appears at the top of the list. See “Add a New Thread” on page 16.
- 2 If desired, check Smooth Blend so that the change from one color to the next is gradual.
- 3 Click the color block and select a color from the Colors window.
- 4 Click Add Color  to add a color to your variegated thread. Another color block appears.
- 5 Click the color block and change the color as desired.
- 6 Add a third color block and change it to the desired color.
- 7 All new colors in a thread are added with a length of 1mm. Select the number for a color and click the up and down arrows, or enter a number, to change the length of the color along the thread.
- 8 To change the position of a color in the list, select the color and click Move Up  or Move Down  to move the color up or down the list.
- 9 To remove a color from the variegated thread, select the number for the color, and click Delete Color .
- 10 Click OK to create the thread.

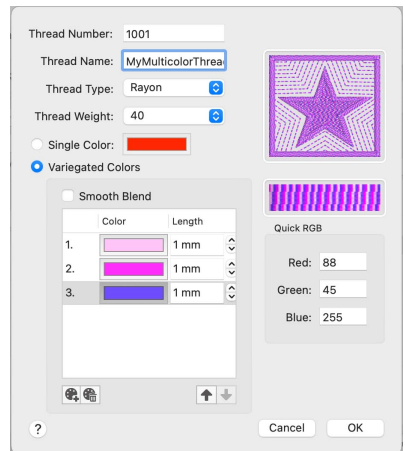

Thread Options

Thread Number

Enter the desired thread number up to 13 characters long. This should be a unique thread number in My Thread Databases.

Thread Name

Enter the desired thread name, which usually a description of the color. The thread name can be up to 29 characters long.

Thread Type

Choose from the following thread types in the pop-up menu:

- Cotton
- Cotton Mercerized
- Fluorescent
- Metallic
- Metallic Holographic
- Metallic Sliver
- Metallic Sparkle
- Polyester
- Rayon
- Silk
- Wool

Thread Weight

Choose from the following thread weights in the pop-up menu:

- 12 (0)
- 18 (1)
- 25 (2)
- 30 (3)
- 35 (4)
- 40 (5)
- 50 (6)
- 60 (7)
- 80 (8)

Note: The number in brackets is used to indicate the thread weight in the abbreviation for the Thread Range.

Smooth Blend

Smooth Blend alters the way the colors in the threads change from one to the next.

- If Smooth Blend is selected (checked), the colors are blended across the point where they meet, so that the change from one color to the next is smooth.
- If Smooth Blend is not selected (unchecked), the color change is abrupt between one color and the next.

Color List

The color list shows the colors that make up variegated threads, and the length of each color section in mm. For newly added threads, there will be one color in the list, set to red with a length of 1mm.

Note: Most threads are single-color threads, which are unaffected by this length setting.

Color Blocks

Change the color for the selected color block in the Colors window (see page 20). Choose a color for your new thread, or set the first color if it is a variegated thread.

- Click a color block to choose a color for that block in the Colors window.

Variegated Thread

The Variegated Thread options are used for multicolor threads.

Add Color

Add a color to the variegated thread colors.

- Click Add Color , then click the color block to select the desired color in the Colors window (see page 20), and to select the color length.

Color Length

All new colors in a thread are added with a length of 1mm. If desired, change the length from the 1mm default. Enter a length in mm from 1mm to 1000mm.

- Select the number for a color and click the up and down arrows, or enter a number, to change the length of the color along the thread.

Note: Subsequent colors will initially be red (RGB 255, 0, 0), and will use the color length of the color above.



Delete

Delete a color from the variegated thread. There is no confirmation. If there is only one color, it will not be deleted.

- Select the number for a color in the list and then click Delete  to remove it.

Move Up and Move Down

Use Move Up  and Move Down  to move colors up and down the list of colors.

- Select the number for a color in the list and then click Move Up  to move it up the list of colors, and Move Down  to move it down the list of colors.

Preview

Preview your selected colors as an embroidery and as thread.

Quick RGB

Enter the RGB (Red, Green, Blue) values for the color in the Quick RGB number fields. See “Red, Green, Blue (RGB) Color Model” on page 20.

Color Models

Hue, Saturation, Luminance (HSL) Color Model

Hue is the color (red, yellow, green, or blue) for the selected color, expressed as a value between 0 and 239. Saturation (Sat) is the strength or purity of color in a specified hue. This is related to the amount of gray in it and is measured from 0 (completely gray) up to a maximum of 240 (no gray). The higher the saturation, the purer or more vivid the color. Luminosity (Lum) is the intensity of lightness or darkness in a color, specified by a value between 0 (black) and 240 (white). If Saturation is 0, the Luminosity setting specifies a shade of gray.

Red, Green, Blue (RGB) Color Model

The RGB model, one of the Additive Color models, is used on computer monitors. It has three primary colors — red, green, and blue — that it creates by emitting light. These three colors are combined in various proportions to produce all the colors displayed on your screen. They are referred to as additive because they combine to produce white. Primary colors are measured as a value from 0-255. The colors produced by combining the three primaries are a result of the amount of each of those shades present. For example, pure red has a red value of 255, a green value of 0, and a blue value of 0. Yellow has a red value of 255, a green value of 255, and a blue value of 0. If Red, Green and Blue are set to zero, the color is black; if all three are 255, they produce white.

Colors Window

Use the Colors window to choose a color for a thread. The nearest shade in the current thread range is selected.

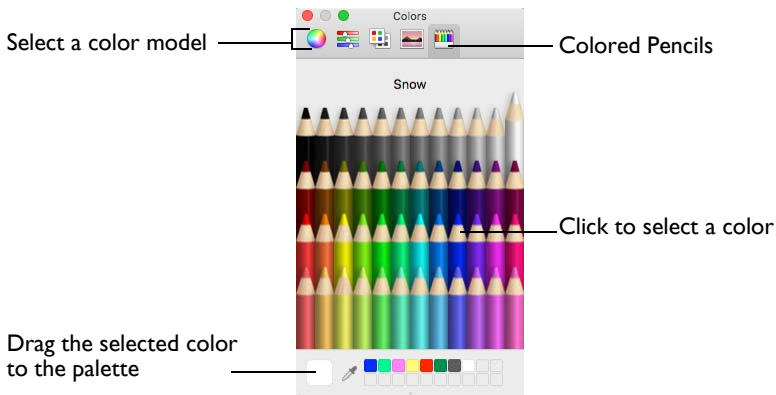

Use the Colored Pencils to select a color quickly.

Note: Other color models show a greater variety of shades: Color Wheel, Color Sliders, Color Palettes and Image Palettes.

Select a color for a thread

- 1 Select a color, then click the color block in the Thread dialog. The Colors window opens.
- 2 Click Colored Pencils  to select the Colored Pencils color model.
- 3 Click one of the 48 pencils. The thread color changes in the Thread dialog. The shade nearest to the pencil shade is used.
- 4 Close the Colors window when you have chosen a color.

Copy Thread

Use Copy Thread  to copy an existing thread in a My Thread database to use as the basis for a new thread definition.

Note: When threads are added to a My Thread database, they are shown in the Color Selection dialog the next time it is used in any part of the mySewnet™ Embroidery Software.

Copy an Existing Thread in a My Thread Database

- 1 Select a thread database in My Thread Databases.
- 2 Highlight a thread in the selected My Thread database list.
- 3 Click Copy Thread  to make a duplicate of that thread at the end of the list.
The new thread has an underline and a number placed at the end of its Thread Number to make it unique in the My Threads list. It is highlighted so you can Edit the thread.

Organize a My Thread Database

You can edit threads in a My Thread database, delete threads and change the order of the threads.



Note: Changes to a My Thread database are shown in the Color Selection dialog the next time it is used in any part of the mySewnet™ Embroidery Software.

Change the Order of a My Thread Database

Threads added to a My Thread database are added at the end of the list. They can be moved up and down the list, so that they are listed in the order you desire.

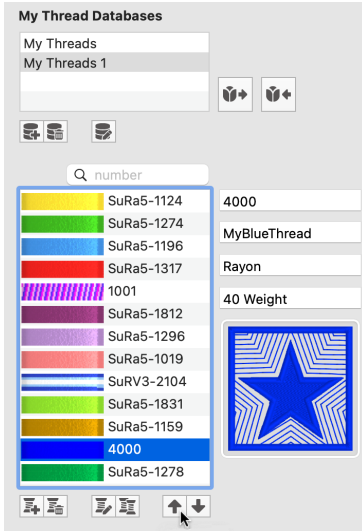
Note: If you do not change the order of the My Thread database the list will show the order in which the threads were added.



- 1 Click the thread that you want to move in the My Thread database. It is highlighted.
- 2 Click the Move Up  and Move Down  buttons to move the thread to the desired position. It remains highlighted while it is moved.
- 3 Repeat until the My Thread database is sorted as desired.

Delete a Thread

Threads may only be deleted from a My Thread database, not from a Standard Thread Database. When deleting, a message appears saying that deleting a thread is permanent and may not be undone.

Note: Deleting from a My Thread database has no effect on the threads in the Standard Thread Database.

- Click a thread to highlight it, and then click the Delete Thread  button. Click Yes to delete the thread.

Edit a Thread

Edit the details for a thread in the Thread dialog. See “Thread Options” on page 17.

To open the Thread dialog

- Click a thread in the My Thread database list, then click Edit . The thread dialog opens.
- Double-click the desired thread in the My Thread database list. The Thread dialog opens.

Add a New My Thread Database

Create a customized My Thread database for your threads.

Create a Personal My Thread Database

- 1 In the My Thread Databases section, click Add New Database .
- 2 In the Thread Database Name dialog, enter a name for the new thread database. A name is suggested (such as "My Threads 1") but you can enter any name you choose.

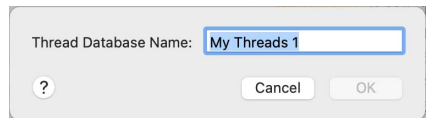

Thread Database Name:

?

Note: If the whole My Thread database is from one new manufacturer, create an appropriate database name and the abbreviation will be added automatically.

- 3 Click OK to create the new database.
- 4 Add threads to the My Thread database as described above.

To rename your My Thread database, click Rename Database  and enter a new name in the Thread Database Name dialog.

To delete a My Thread database, click Delete Database  and click Yes to confirm.

Thread Database Name

Use the Thread Database Name dialog to name and rename your My Thread databases.

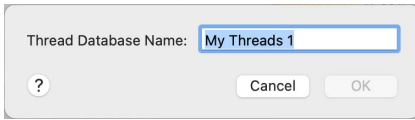

- In the My Thread Databases section, click Add New Database  and in the Thread Database Name dialog enter a name for the database. Click OK to save the database name.

Delete My Thread Database

You can delete a My Thread database in the My Thread Databases section. A warning message is displayed before the thread range is deleted, saying that deleting a thread is permanent and may not be reversed.

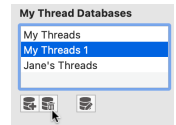

- In the My Thread Databases section, click Delete Database , and click Yes to confirm.

Rename My Thread Database

You can rename a My Thread database in the Thread Database Name dialog.

- Click Rename Database  to rename the selected My Thread database. The Thread Database Name dialog opens.

Import Threads From Embroidery

Use Import Threads From Embroidery  to import custom threads from an embroidery given to you by a friend.

If another user gives you any .vp4 or .vp3 format embroideries they have created, the embroideries may contain custom thread definitions from their My Threads databases that you do not have in your own My Threads databases. You can use the Import Threads From Embroidery function to add another user's thread definitions to your My Threads databases.

Note: This is also useful if you delete one of your own custom thread definitions and then wish to recover it from an embroidery that used it.

Import Threads from an Embroidery

- 1 Click Import Threads From Embroidery  and an Open dialog appears where you can select the desired .vp4 or .vp3 embroidery file.
- 2 Browse to and select the desired .vp4 or .vp3 format embroidery file, and then click Open to import any custom thread definitions that do not appear in your My Threads database.
- 3 If a thread in the embroidery uses the same number and thread database name as one of your threads, you are asked if you want to overwrite it.

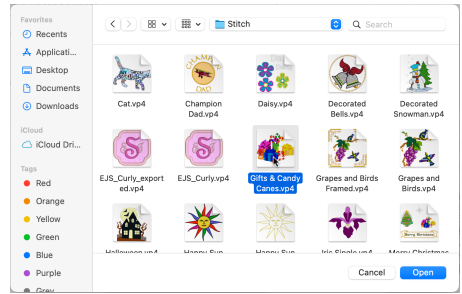

Note: This message appears if you import one of your own custom threads, as well as if a completely different thread is imported. A thread definition gives the name, number, thread type and weight, and the color for the thread (or colors for a variegated thread).

- 4 Select Yes, or Yes to All to overwrite your existing thread definitions, or No, or No to All keep your existing thread definitions.
- 5 When all of the threads have been imported, a message is displayed saying how many threads were added. Click OK to finish. The threads are added to the end of your My Threads list.
Note: When you import a thread list created with Export Threads to Embroidery, the threads are imported into a My Threads database using the same name as the original database. See “Export Threads to Embroidery” on page 24.

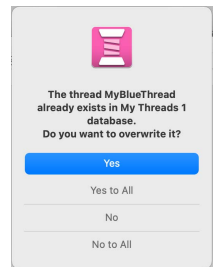

Importing Threads from Other File Types

As the .vp4 and .vp3 formats are the only embroidery file formats that can contain the full thread information used by the mySewnet™ Embroidery Software apps, you cannot add custom thread definitions from any other embroidery file type.

You cannot import thread definitions directly from mySewnet™ Digitizing (.edo) or mySewnet™ Cross Stitcher (.krz) design files. To import custom thread definitions from one of these file types, create a Husqvarna Viking/Pfaff .vp4 embroidery file from the unmodified design in mySewnet™ Digitizing or mySewnet™ Cross Stitcher, and then import the custom thread definitions from the embroidery.

Note: Use Check for Updates in mySewnet™ Configure to check for any updated thread definitions in the Standard Thread Database. You cannot import new standard thread definitions with Import Threads from Embroidery.

Export Threads to Embroidery

Use Export Threads to Embroidery  to create a .vp4 embroidery from the selected My Threads database to act as a backup, or to give to another user.

Export Threads to Embroidery saves all the thread definitions in the selected My Threads database as a .vp4 embroidery using the thread database name, with a block for each thread color.

Note: When imported using Import Threads From Embroidery , the threads from the embroidery are imported into a My Threads database with the same name as the original database.

- If a database of that name is already present (for example, My Threads 1), any new threads are imported into that thread database.
- If no database of that name is present, a new database is created.

Export Threads to an Embroidery

- 1 In the My Threads Databases window, select the desired My Threads database.
- 2 Click Export Threads to Embroidery . A Save As dialog appears for you to save the .vp4 embroidery file.

Note: By default, the embroidery file uses the name of the My Threads database.

- 3 Save the embroidery file.

Note: Each color in the thread database is saved as a block of color in the My Threads database embroidery.

- 4 Place the embroidery file among your backups, or give it to a friend to add the threads to their thread databases.
- 5 To view the threads in the embroidery, open it in mySewnet™ Embroidery.

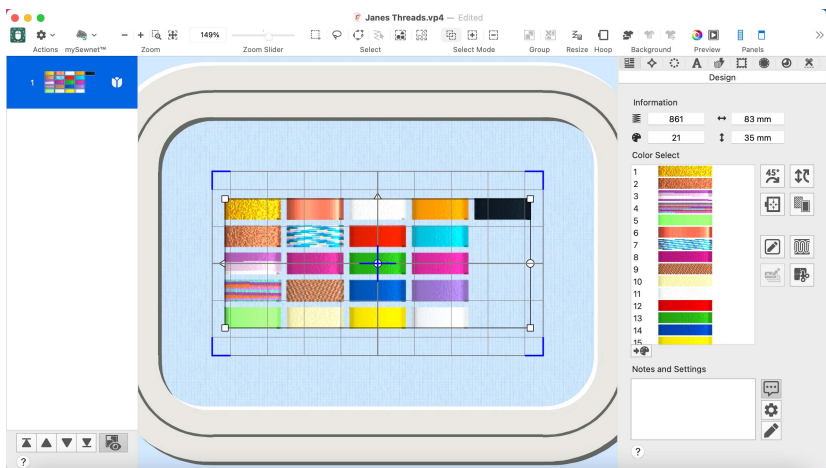

Note: Each color in the thread database is saved as a block of color in the My Threads database embroidery, with the name of the My Threads database set as the thread range.

- 6 To add the threads in the embroidery to your thread databases use Import Threads From Embroidery .

The threads are imported into a My Threads database using the same name as the original database.

Note: If a thread is already present, it will not be imported.

Use My Thread Stock to review your stock of threads, and to print a list, or upload it to the Thread Cache website to view on your mobile device.

Use the My Thread Stock window of mySewnet™ Thread Cache to sort the threads in any order, and note the quantity that you have of each thread in the selected My Thread Database. Print a My Threads shade card, or upload the thread list to the Thread Cache website to view on your mobile device.

To open the My Thread Stock window

- In mySewnet™ Thread Cache, click the My Thread Stock button.
- Choose View > My Thread Stock
- Press ⌘3

My Thread Stock

Use the My Thread Stock window of mySewnet™ Thread Cache to note the quantity that you have of each thread in the selected My Thread Database, and to print the list or upload it to the Thread Cache website, ready to view on your mobile device.

mySewnet™ Thread Cache

My Thread Ranges My Thread Databases My Thread Stock

My Thread Database: My Threads [Print] [Upload]

★	Color	Number	Name	Type	Weight	Spools	Size	Notes
	Gold	RaMJ5-1001	Gov't. Gold	Metallic	40	0	1,000 m	
	Copper	RaMJ5-1004	Copper	Metallic	40	1	1,000 m	
	3CC Purple	RaRV4-6848	3CC Purple	Rayon	35	1	1,000 m	
	Wild Rose	SuCV0-4082	Wild Rose	Cotton	12	1	1,000 m	
	Neon Green	RaPNS-5814	Neon Green	Fluorescent	40	1	1,000 m	
	Lt. Copper	SuMS3-8011	Lt. Copper	Metallic Silver	30	1	1,000 m	
	Peacock Blue	SuMH3-6017	Peacock Blue	Metallic Holographic	30	0	1,000 m	
	Dark Rose	YSB-089	Dark Rose	Silk	50	1	1,000 m	
	Brackan	SuLW0-3846	Brackan	Wool	12	1	1,000 m	
	Yellow ExtraGlow	SgNLS-2	Yellow ExtraGlow	Cotton	40	0	1,000 m	
	White / Green	SpSu5-2	White / Green	Cotton	40	1	1,000 m	
	Red	RaRa5-2378	Red	Rayon	40	2	1,000 m	
	Harvest Green	RaRa5-2578	Harvest Green	Rayon	40	0	1,000 m	
	Soldier Blue	RaRa5-2527	Soldier Blue	Rayon	40	2	1,000 m	
	Daffodil	RaRa5-2326	Daffodil	Rayon	40	2	1,000 m	
	Yellow	RaRa5-2213	Yellow	Rayon	40	2	1,000 m	
	Periwinkle	RaRa5-2306	Periwinkle	Rayon	40	0	1,000 m	
	Passion	RaRa5-2291	Passion	Rayon	40	2	1,000 m	
	Iris	RaRa5-2288	Iris	Rayon	40	2	1,000 m	

Quick Spool Count: +1 -1 [Reset Sort Order] [Close]

My Thread Stock window features and callouts:

- Select a My Thread database (My Threads)
- Upload the selected database (Upload button)
- Print the selected database (Print button)
- Sort by the column headings (column headers)
- Click to select a thread (star icon)
- Control-click to edit Spools and Notes (star icon)
- Return to the original order (Reset Sort Order button)
- Change the number of spools for the selected threads (Quick Spool Count: +1 -1)

Edit Spools and Notes for the selected threads
Click to highlight a thread with a star

View the thread stock in a My Thread database

- In mySewnet™ Thread Cache click the My Thread Stock button, then choose a personal thread database in the My Thread Database pop-up menu.

To learn how to	Go to
Sort the threads in a My Thread database	See “Viewing and Sorting Threads in a My Thread Database” on page 27.
Change the number of thread spools and their size in a My Thread database	See “Viewing and Sorting Threads in a My Thread Database” on page 27.
Add notes to your threads	See “Viewing and Sorting Threads in a My Thread Database” on page 27.
Edit the notes and spool size for several threads at one time	See “Edit Selected” on page 29.
Upload your My Thread database to the Thread Cache website, ready to view on your mobile device	See “Upload a My Thread Database to the Cloud” on page 33.



Viewing and Sorting Threads in a My Thread Database

- 1 In mySewnet™ Thread Cache click the My Thread Stock button.
- 2 Choose the desired My Thread database in the My Thread Database pop-up menu.
- 3 Click the Name column heading. The database is sorted by name.
You can sort by name, thread number, thread type, thread weight, number of spools, spool size and notes. You can also sort by Star threads (those you have highlighted).
- 4 Click the Reset Sort Order button. The list returns to its original order.
Note: This is the sort order that you set in the My Thread Databases window. See “Change the Order of a My Thread Database” on page 21.
- 5 Highlight a thread, and then click the Notes field for that thread to open it for editing. Alternatively, double-click to open the Notes field.
- 6 Enter the text "5 spools needed" and press Return. The note is added to that thread.
- 7 Highlight a thread, and then click the Spools field for the thread.
- 8 Increase the number of spools for that thread by one and press Return. The spool number has changed.
Note: You can edit the Notes and the number of spools for threads individually.
- 9 Click the Quick Spool Count -1 button. The number of spools decreases by one. The Quick Spool Count buttons are an alternative way to change the spool count.
- 10 Command-click to select three threads. All three are highlighted.
- 11 Click the Quick Spool Count +1 button. The number of spools increases by one for all three threads.
This is a quick way of changing the number of spools for several threads.
- 12 With the three threads still selected, click the Edit Selected button to open the Edit Selected dialog.
- 13 Select (check) the "Set number of spools to all selected" checkbox.
- 14 Set the number of spools to 3, then click OK.
All three threads are now listed as having 3 spools.

- 15 With the three threads still selected, click the Edit Selected button again.
- 16 Select (check) the "Set spool size to all selected" checkbox.
- 17 Choose a different spool size from the pop-up menu.
Note: You can also use yards instead of meters as the measurement unit.
- 18 Select (check) the "Set notes to all selected" checkbox.
- 19 Enter the text "3 spools needed" in the Notes text box.
- 20 Click OK to close the dialog. The three selected threads now use a different spool size, and show the 3 spools note.
- 21 Click in the Star column for the first of your selected threads. The thread is highlighted with a star.
- 22 Add a star to the other two edited threads.
- 23 Click the column header star to sort by this column. All of the highlighted threads are now listed together.
Note: This is a good way to review your highlighted threads.
- 24 Click the Reset Sort Order button. The list returns to its original order.

Thread Stock Information

View and edit the information for the threads in a My Thread database.

★	Color	Number	Name	Type	Weig...	Spools	Size	Notes
★		SuCV0-4082	Wild Rose	Cotton	12	1	1,000...	
★		RaRV4-6848	3CC Purple	Rayon	35	1	1,000...	5 spools needed

Star

Use a star to highlight a thread in the database, for example to order more spools.

- Click in the Star column for a thread. The thread is highlighted with a star.

Color

The color block for the thread.

Number

The thread number, with the abbreviation for the thread range.

Name

The manufacturer or personal thread name.

Type

The thread type. See "Thread Type" on page 18.

Weight

The thread weight. See "Thread Weight" on page 18.

Spools

The number of spools you have of the thread.

- Click the spool field and enter the number of spools you have of that thread.
- Click the Quick Spool Count buttons to add a spool or remove a spool.

- Select several threads and click the Edit Selected button to change the number in the Edit Selected dialog. See “Edit Selected” on page 29.

Size

The length of thread on each spool.

- Select one or more threads and click the Edit Selected button to change the spool size for the thread(s) in the Edit Selected dialog.

Notes

Notes about the thread, for example the number of spools needed.

- Click the Notes field and add a note for the thread.
- Select several threads and click the Edit Selected button to add a note in the Edit Selected dialog.

Edit Selected

Use the Edit Selected dialog to edit the notes and spool information for the selected threads.

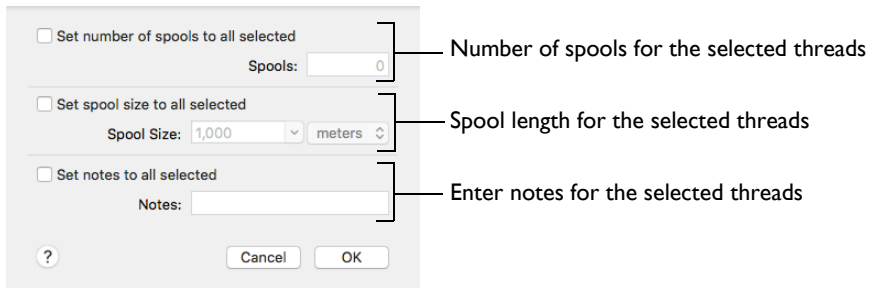

- Select one or more threads and click the Edit Selected button to open the Edit Selected dialog. Click OK to save your changes.

Spools

Set the number of spools you have of the selected threads.

- Select (check) the "Set number of spools to all selected" checkbox, then enter the number of spools in the number box.

Spool Size

Set the length of the thread on the spool. Choose from 225, 250, 1000, 1100 and 5000, and set the measurement units as meters or yards.

Note: Set the default spool size and measurement units in the Preferences dialog. See “Preferences” on page 40.

- Select (check) the "Set spool size to all selected" checkbox, then choose a thread length from the pop-up menu. You can also change the measurement units in the second pop-up menu.

Notes

Add notes for the selected threads, for example the number of spools needed.

- Select (check) the "Set notes to all selected" checkbox, then enter the desired text in the Notes text box.

Print

Use the Print dialog to select your print settings, and to print a list of threads for the selected My Thread database.

Select Show Details to choose the My Thread Database and the information to be printed with the thread list, set the sort order, and select the printer and page layout. Then print the thread list.

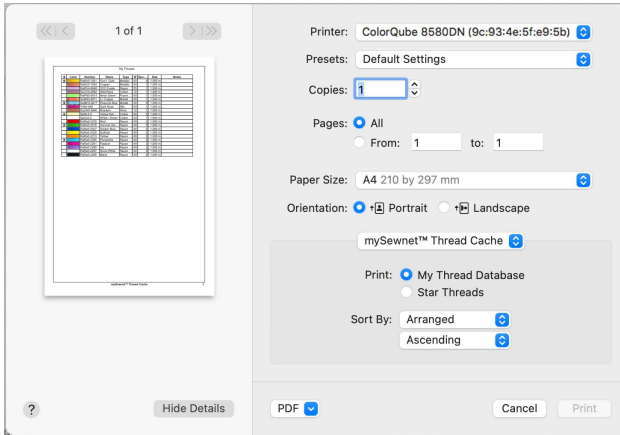



To open the Print dialog

- In the My Thread Stock window, click Print .
- Choose File > Print
- Press ⌘P

Preview

Display the thread list as it would appear when printed.

If there are multiple pages, step through them with Next Page  and Previous Page .

mySewnet Thread Cache

Print: Print either the full database list, or only the Star threads. See “Star” on page 28.

- Select My Thread Database to print the full database, or Star Threads to print details for only the highlighted threads.

Sort By: Sort the threads as Arranged in the list, or sort by Star, Number, Name, Type, Weight, Spools, Size or Notes. Use ascending or descending order.

- Choose a sort type from the pop-up menu, then choose ascending or descending order.

My Thread Database: Select the personal thread database to print.

- Choose a My Thread database from the pop-up menu.

PDF

Choose PDF creation settings.

Hide Details

View a concise version of the Print dialog.

Printer

Select the printer you want to use.

Presets

Choose a saved printer setup.

Copies

Select the number of Copies you wish to print, and whether to print on two sides.

Pages

Select the range of pages you wish to print.

Paper Size

Select the size of paper that the thread list is to be printed on.

Orientation

Choose Portrait or Landscape.

Settings Menu

Select the settings details for the following from the pop-up menu under the app name:

- Layout
- Color Matching
- Paper Handling
- Paper Feed
- Cover Page
- Supply Levels

Layout

Choose the number of pages per sheet, whether to use a border, and whether to print on two sides, reverse the page orientation, and flip horizontally.

Color Matching

Select the color match profile.

Paper Handling

Select page order, whether to collate pages, which pages to print, and scale relative to paper size.

Paper Feed

Select your paper source.

Upload

Use Upload  to upload your My Thread database to the mySewnet™ Thread Cache website.

To Upload your threads

- In the My Thread Stock window, click Upload .
- Choose File > Upload
- Press ⌘U

Upload a My Thread Database to the Cloud

- 1 In mySewnet™ Thread Cache click the My Thread Stock button.
- 2 Choose the desired My Thread database in the My Thread Database pop-up menu.
- 3 Click the Upload button . Your threads are uploaded to the mySewnet™ Thread Cache website for viewing on your mobile device.

Note: If that My Thread database was previously uploaded, the old version will be overwritten. Any thread Purchase information is removed.

Transfer your thread database from your Mac to the Thread Cache web database to view on mobile phone or tablet. Use the Thread Cache website to view your chosen threads, and note your purchases as you visit different stores.

Use the Thread Cache website on your mobile device to see your My Thread databases. View all threads, or Star threads, and note your purchased threads.

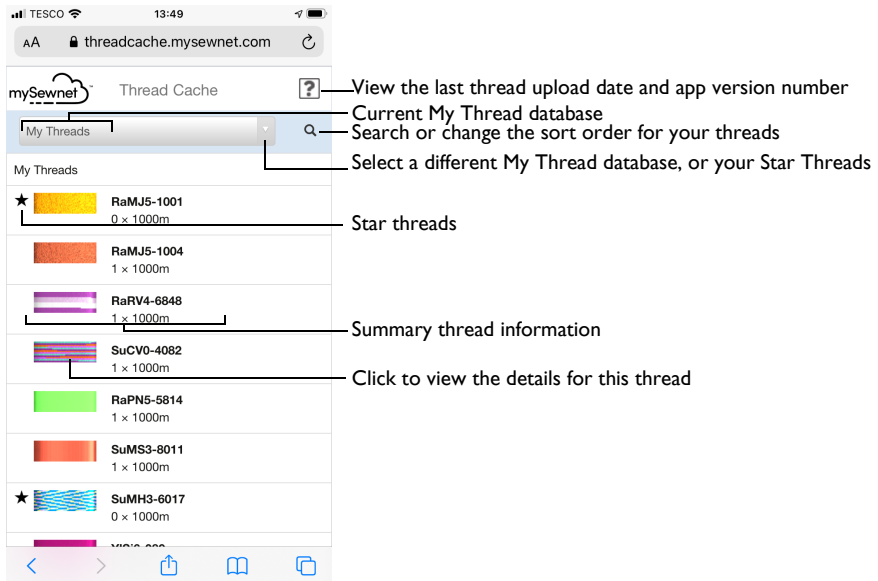

Note: The Thread Cache website can be used on most mobile devices.

To learn how to	Go to
Open the Thread Cache website on your phone or tablet	See “Open the Thread Cache Website on your Phone or Tablet” on page 35.
Choose a different My Thread database	See “Choose a Different My Thread Database” on page 37.
Mark a thread as purchased	See “Set a Thread to Purchased” on page 39.
Set the sort order for the threads	See “Choose a Sort Order for the Thread Database” on page 37.
View the details for a thread	See “Details” on page 38 and “Select a Thread” on page 36.
Select and view your Star Threads	See “Display your Star Threads” on page 37.

View Your Threads on Your Mobile Device

Enter your Cloud Connection details to view your thread databases on your mobile device.

Open the Thread Cache Website on your Phone or Tablet

- 1 Open the web browser on your phone or tablet.
- 2 Browse to threadcache.mysewnet.com.
- 3 If needed, enter your mySewnet™ account email address and password to view your threads.
- 4 The thread databases that you uploaded to the mySewnet™ website are displayed. See “Upload a My Thread Database to the Cloud” on page 33.

Using the Thread Cache website on your mobile

Use the Thread Cache website to view the threads in your My Thread databases on your mobile device.

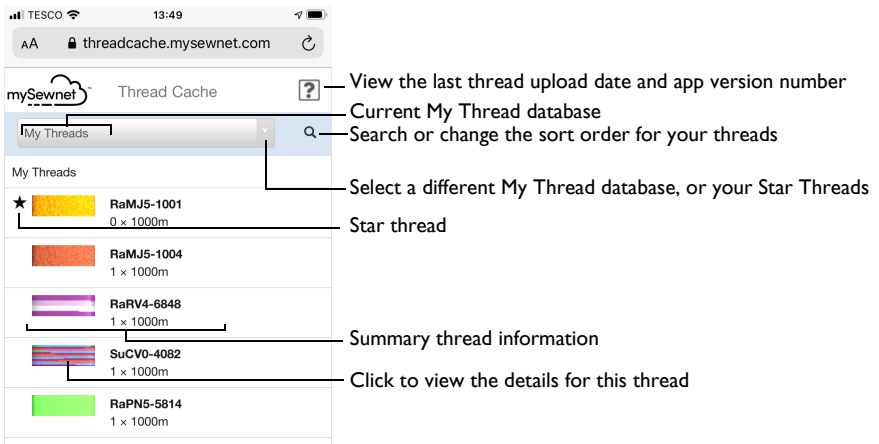

- On a phone or other narrow screen device, tap to view the details for a thread.

View the last thread upload date and app version number

View the details for the selected thread

Select another database, or Star threads

Current My Thread database

Search, or change the sort order for your threads

Summary thread information

Select a thread to view its details

Purchased Star thread

Star thread

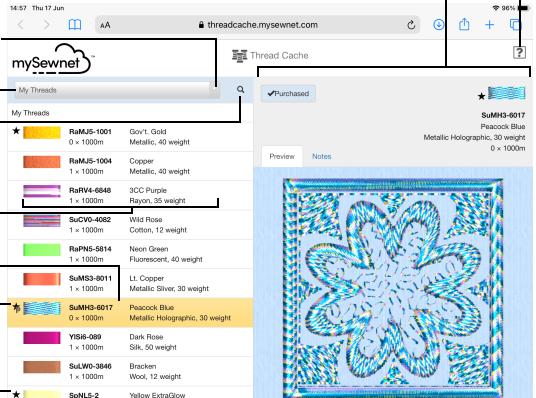

- On a tablet or other wide screen device, the details for the selected thread are displayed.

Select a Thread

- 1 On your mobile device, open the Thread Cache website: threadcache.mysewnet.com
- 2 In the main window, tap the desired thread.

On a tablet the thread details are displayed in the pane on the right. On a phone the thread details are displayed on a separate page.

See “Details” on page 38.

Note: Use mySewnet™ Thread Cache to update your threads on the website.

Display

In the Display pop-up menu, choose a My Thread database, or Star Threads.

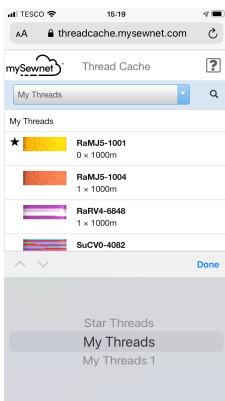

Phone

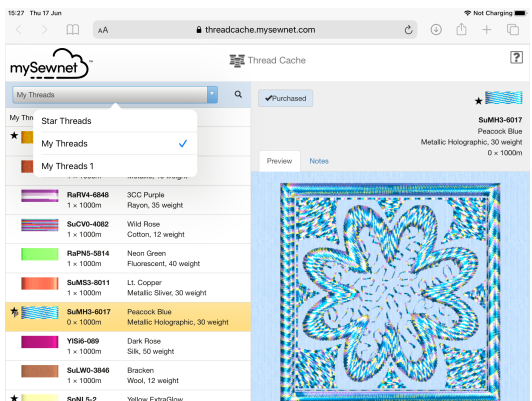

Tablet

Choose a Different My Thread Database

Use the My Threads database pop-up menu to select a My Thread database or Star Threads.

- 1 On your mobile device, open the Thread Cache website: threadcache.mysewnet.com
- 2 In the main window, select a My Thread database from the pop-up menu, or choose Star Threads to view only your Star threads.

Display your Star Threads



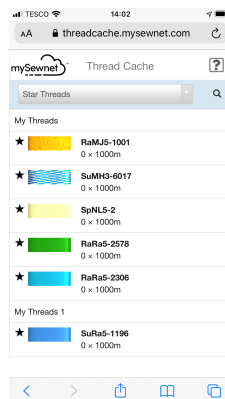

- 1 Highlight the desired threads with a star in mySewnet™ Thread Cache. See “Viewing and Sorting Threads in a My Thread Database” on page 27 and “Star” on page 28.
- 2 Upload your updated My Thread database to the mySewnet™ Thread Cache website. See “Upload a My Thread Database to the Cloud” on page 33.
- 3 On your mobile device, open the Thread Cache website: threadcache.mysewnet.com
- 4 In the main window, select Star Threads in the My Threads database pop-up menu. The Star Threads in your My Threads databases are displayed.



Sort By



Set the sort order for your threads.

Choose a Sort Order for the Thread Database

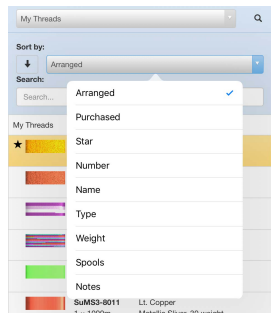
- 1 On your mobile device, open the Thread Cache website: threadcache.mysewnet.com
- 2 In the main window, tap Search .
- 3 Select a Sort Order from the Sort By pop-up menu.
- 4 Tap Ascending  or Descending  to set the order of the threads shown.
- 5 In Search enter part of the name or code for a thread to search for it by name or number. For example, 'bl' will search for blue and black threads.
- 6 Tap Search  again to close the Search and Sort area.



Order

Tap to set Ascending  or Descending  to show your sorted list in ascending or descending order.

Arranged

Use the order that you set for that My Thread database in mySewnet™ Thread Cache on your Mac. See “Change the Order of a My Thread Database” on page 21.

Purchased

Sort by the threads tagged as Purchased. See “Set a Thread to Purchased” on page 39.

Star

Sort by the threads highlighted with a star. See “Star” on page 28.

Number

Sort by the thread number. See “Thread Number” on page 17.

Name

Sort by the thread name. See “Thread Name” on page 17.

Type

Sort by the fiber used for the thread. See “Thread Type” on page 18.

Weight

Sort by the thread weight. See “Thread Weight” on page 18.

Spools

Sort by the number of spools of the thread. See “Spools” on page 28.

Notes

Sort by the text in the Notes field for the thread. See “Notes” on page 29.

Details

The details for the selected thread show the thread information (range, number, name, type and weight), whether it is starred, any notes, and a preview using the thread. Set the thread to Purchased when you have added to your stock.

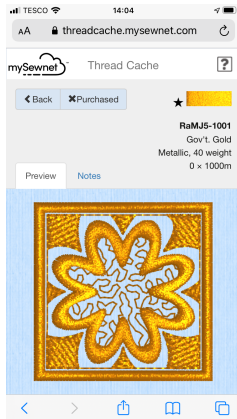

Phone

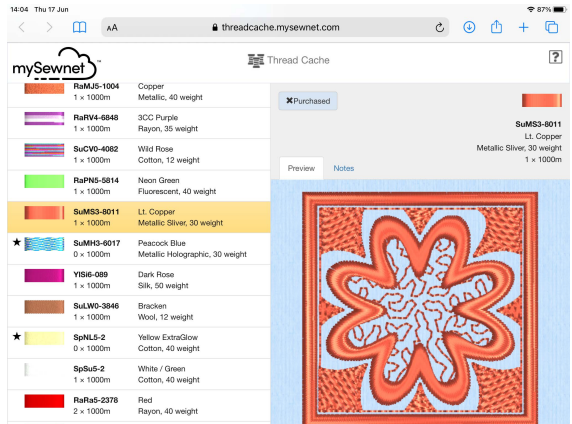

Tablet

View the details for a thread

- On a tablet, tap to highlight a thread. The thread details are displayed in the pane on the right.
- On a phone, tap the thread name to view the Thread window.

Set a Thread to Purchased

- 1 On your mobile device, open the Thread Cache website: threadcache.mysewnet.com
- 2 In the main window, tap to select a thread.
- 3 In the Thread pane, tap Purchased to select the Purchased button. In the My Threads window, the thread is now marked with a P.
- 4 When you are back at your Mac, update the thread spool information in your My Thread databases in mySewnet™ Thread Cache.

Note: Information on Purchased threads is not preserved when a My Thread database is next updated on your mobile device.

Use Preferences to set the default spool size for your threads, and choose the measurement units for display.

Use Preferences to set the default spool size for your threads, and to choose which measurement units to use. When default spool size is changed, the new settings are remembered when mySewnet™ Thread Cache is closed and reopened.

To open Preferences

- Choose mySewnet™ Thread Cache > Preferences.
- Press ⌘,

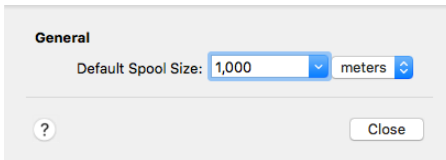

Default Spool Size

Choose the default thread spool size size from 225, 250, 1000, 1100 or 5000 meters or yards. The initial setting is 1,000 meters.

- Choose the Default Spool Size from the pop-up menu.

Measurement Units

Use meters or yards for the thread length measurement.

- Choose yards or meters from the pop-up menu.

Error Messages

Using mySewnet™ Thread Cache

"This action is permanent and may not be reversed. Do you wish to continue?"

This message appears if you try to delete a thread definition from a My Thread database, or to delete a My Thread database. If you wish to go ahead and delete the thread, click Yes. Otherwise click No.

"The thread XX already exists in the selected Thread Database. Do you want to overwrite it?"

This message appears if you try to use an existing thread name in a My Thread database. If you wish to overwrite a single thread name, click Yes, otherwise click No. If multiple threads are selected, to overwrite the names click All, otherwise click None.

Miscellaneous

"Not enough memory available to perform function."

This message appears if system resources are low. Close other programs and try again. If this does not work, try restarting your computer.

Other Topics

General Use of My Threads

Colors in mySewnet™ Embroidery Software Files

The mySewnet™ Embroidery Software displays threads in a file in the same way on any computer where it is installed. That is, the colors used are the same even if they are reproduced slightly differently on different monitors. You can print a worksheet to see the colors and color names used in a particular design. This is true, even if you do not have all the threads in a design defined in the Standard or My Thread databases on your computer. This is because a mySewnet™ Embroidery Software design has complete information for each of the threads it uses.

Any of the following file types is a 'design' that has full mySewnet™ Embroidery Software thread definitions:

- Husqvarna Viking/Pfaff .vp4 or .vp3 embroidery file
- mySewnet™ Digitizing .edo design outline file
- mySewnet™ Cross Stitcher .krz cross stitch design file

Note: Only Husqvarna Viking/Pfaff .vp4 or .vp3 embroidery files can be used to import custom thread definitions into a My Thread database.

Each thread used in a design falls into one of the following categories:

- A thread you have added to a My Thread database from the Standard Thread Database and which you have not changed. This will apply to most of your colors if you have used a My Thread database to catalogue your thread collection.
- A thread from the Standard Thread Database.
- A thread which you formerly added to a My Thread database from the Standard Thread Database, used in some designs and then deleted from the My Thread database.
- A custom thread that has been added to a My Thread database. You could have added this yourself or added it to a My Thread database from a design from somebody else.
- A thread from the Standard Thread Database that is not on your own Standard Thread Database because your database is out of date.
- A custom thread defined in the file that does not appear in the your My Thread database.

The availability of threads in the Standard Thread Database and My Thread databases will only affect parts of the mySewnet™ Embroidery Software where you can change colors. For example:

- Editing apps: mySewnet™ Embroidery and mySewnet™ Stitch Editor
- Design apps: mySewnet™ Digitizing, mySewnet™ Cross Stitcher, mySewnet™ QuickFont

Below are some situations you may encounter according to the availability of thread definitions, as categorized above.

"I have a vp4 or vp3 embroidery from another user that uses a custom thread definition they designed in a My Thread database."

If you attempt to change the color, a message appears to indicate that the thread is not found in My Threads, and the nearest My Threads match is selected. Use Import Threads from Embroidery to import the custom threads, or select a replacement thread.

"I have a design with My Thread colors that are unmodified copies from the Standard Thread Database, but they are not in my My Thread database."

If you open a file that has colors from a My Thread database that are unmodified copies of standard threads, but do not exist as copies in your My Thread database, the color is identified and selected in the original thread range when you click the color to change it.

"I have a design with custom colors that have been deleted from My Thread database."

If you attempt to change the color, a message appears to indicate that the thread is not found in your My Thread database, and the nearest My Thread match is selected. Select a replacement thread, or import the threads with Import Threads from Embroidery.

"I have a design from another user that uses threads from the Standard Thread Database that I do not have."

Use Check for Updates in mySewnet™. Configure to check for the latest thread database.

"How do I add Color Effects to my thread stash?"

Color Effects cannot be added in mySewnet™ Thread Cache. Add Color Effects to selected threads within a design using the Color Selection dialog in other mySewnet™ Embroidery Software apps.

Index

A

Abbreviation	
Thread	15
About	2
Add	
New Thread to My Threads	16
Standard Threads to My Threads	15
Thread Range to My Thread Ranges	11
Add Color	19
App	
Thread Cache	34
Arranged	37

B

Backup	9
Blend	18
Blue	20

C

Change	
Order of My Thread Database	21
Order of My Thread Ranges	11
Close	2
Color	
Edit	18
List	18
Models	19
Color Blocks	18
Color Length	19
Color Palettes	20
Color Sliders	20
Color Wheel	20
Colored Pencils	20
Colors Window	20
Copies	
Print Number	32
Copy	
Existing Thread in My Threads	20

D

Default Spool Size	40
Default Thread Length	40
Delete	
Color	19
My Thread Database	23
Thread	22
Thread Range in My Thread Ranges	12
Delete Database	23
Details	38
Display	36

E

Edit	
Color	18
Length	19
Thread	22

Edit Selected	27, 29
Error Messages	41
Export Threads to Embroidery	24

F

Fiber	
Thread	38
Find Threads	14
Find Threads in	
My Thread Databases	15
Standard Database	14
Finding Information	1

G

Getting Started	1
Green	20

H

Help	1
HSL	19
Hue Saturation Luminance (HSL)	
Color Model	19

I

Image Palettes	20
Import Threads From Embroidery	23
Install Thread Cache	35
Integrated Help	1
iOS Mobile Device	26
iPad	34
iPhone	34
iPhone and iPad website	34
iPod touch	34

L

Luminance	19
-----------	----

M

Maximize	2
Minimize	2
Mobile Device	34
Move Down	19
Move Up	19
Multiple Threads	
Edit	29
My Thread Database	
Add New Thread to	16
Add Standard Threads to	15
Change Order	21
Copy Existing Thread	20
Find Threads	15
Sort Threads	27
View Threads	27
My Thread Databases	5, 13
My Thread Ranges	4, 10
Add Thread Range to	11
Change Order	11

Delete Thread Range	12
My Thread Stock.....	6, 26
mySewnet™ Thread Cache	
Using	3
N	
Name	28, 38
Notes	27, 30, 38
Number	28, 38
O	
Organize	
My Thread Database	21
My Thread Ranges	11
Orientation	
Print Setup	32
Other Topics	41
P	
Paper	
Size	32
PDF	
Create	32
PDF Guides	1
Pencils	20
Phone	34
Preferences.....	40
Preview.....	19
Print	
My Thread Database	31
PDF Guides	1
Printer	
Print Setup	32
Purchase Information	
Removal.....	33
Purchased	38
Purchased Threads.....	39
Q	
Quantity	
Threads	26
Quick RGB	19
Quick Spool Count.....	27
Quit mySewnet™ Thread Cache	2
R	
Readme	1
Red Green Blue (RGB) Color Model.....	20
Reference Guide.....	1
Restore.....	9
RGB.....	20
Quick	19
S	
Sample Files	1
Saturation	19
Selected Threads	

Edit.....	29
Size	
Paper	32
Smooth Blend	18
Sort By	37
Print	31
Spool Size	29
Default.....	40
Spools.....	28, 29, 38
Standard Thread Database	
Update.....	5, 14
Star	38
Starred	28
Starred Threads.....	37
Start mySewnet™ Thread Cache	2
T	
Tablet	34
Thread	
Delete	22
Edit.....	22
Name	17
Number	17
Options	17
Quantity	26
Type	18
Variegated.....	17, 18
Weight	18
Thread Cache App.....	34
Thread Database	
Update.....	5
Thread Database Update	14
Thread Length	
Default.....	40
Thread Stock Information	28
Threads	
Find	14
Find in My Thread Databases	15
Find in Standard Database	14
Import	23
Troubleshooting	41
Type	28, 38
U	
Update	
Standard Thread Database	5, 14
Update Website.....	36
Upload.....	33
V	
Variegated Thread.....	17, 18
View and Print PDF Guides	1
W	
Weight	28, 38